



QEEG Clinical Report

BrainLens V0.4

Report Description



Personal & Clinical Data

Name	Neshat Habibi	Date of Recording	2025-05-01
Date of Birth - Age	1985-07-02 - 40	Gender	Female
Handedness(R/L)	Right	Source of Referral	Dr Saemi
Initial Diagnosis	Mood Swing-Overthinking-Paranoid-Schizophrenia		
Current Medication	-		

Dr Saemi

Z Score Summary Information (EC)

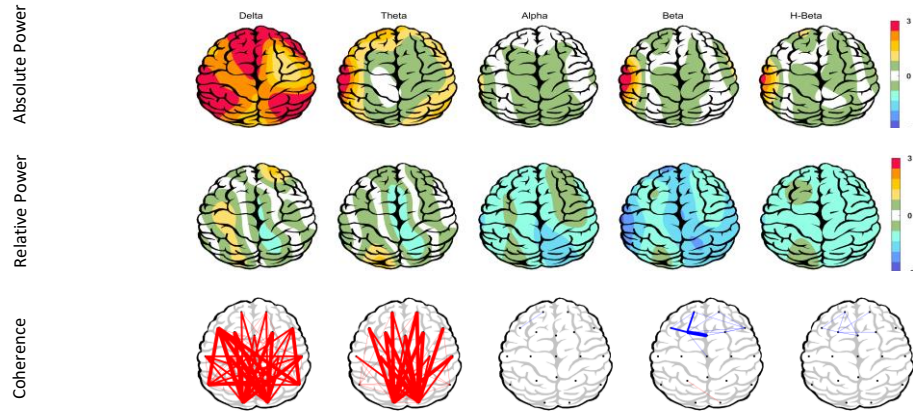

Z Score Summary Information (EO)

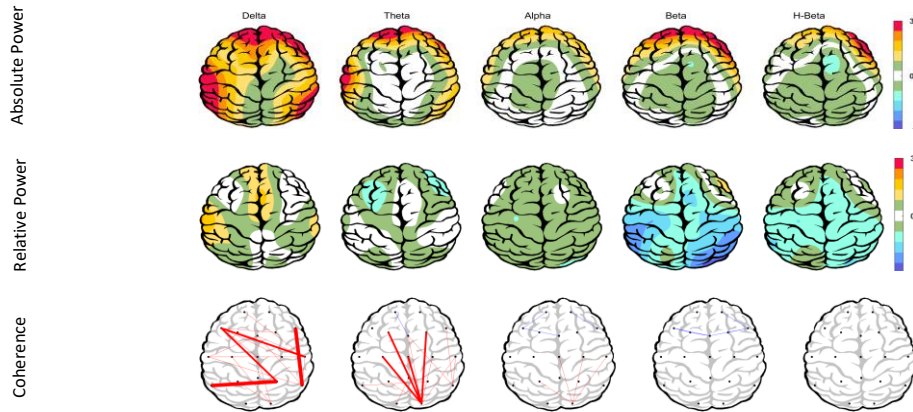

E.C.T/B Ratio (Raw- Z Score)

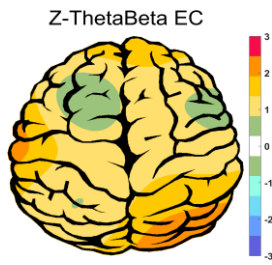
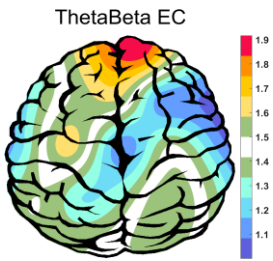

Arousal Level

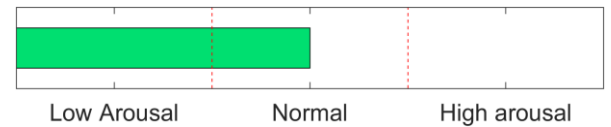
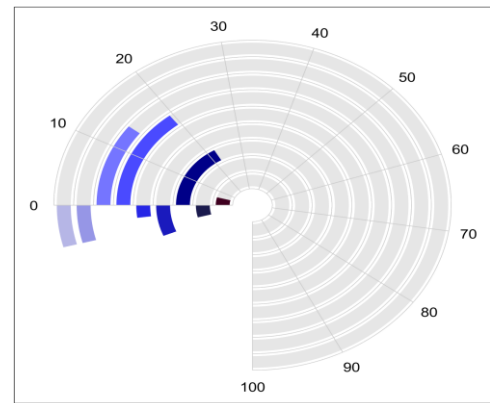

E.O.T/B Ratio (Raw- Z Score)

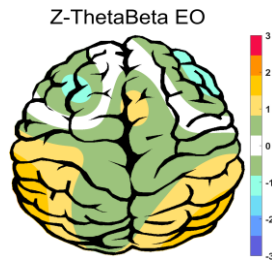
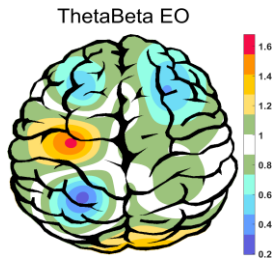

APF(EO)

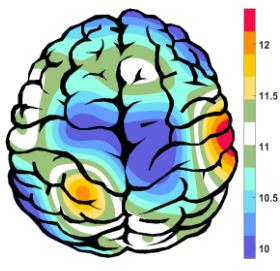

Frontal APF= 10.33
Posterior APF= 10.25

APF(EC)

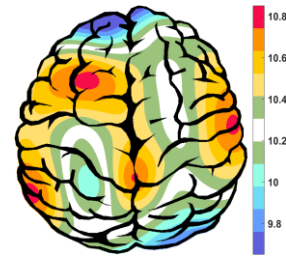

Frontal APF= 10.25
Posterior APF= 10.62

EEG Spectra

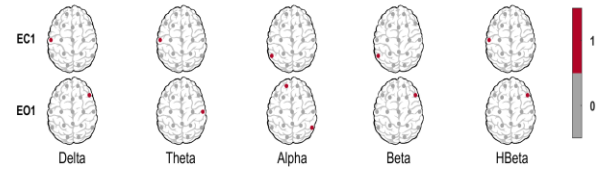
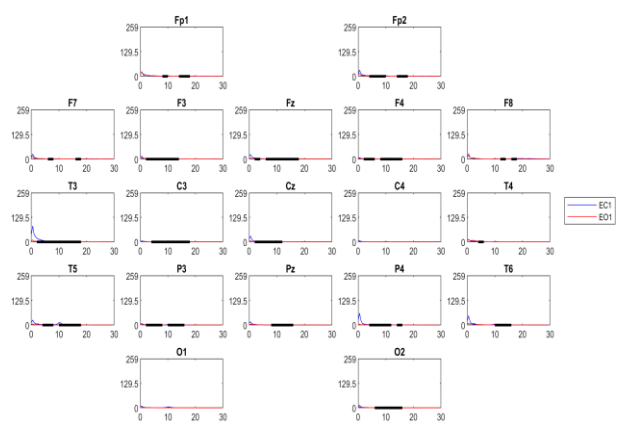
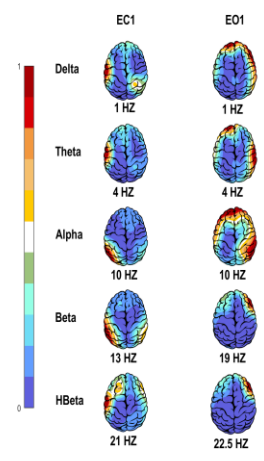

Alpha Asymmetry(AA)

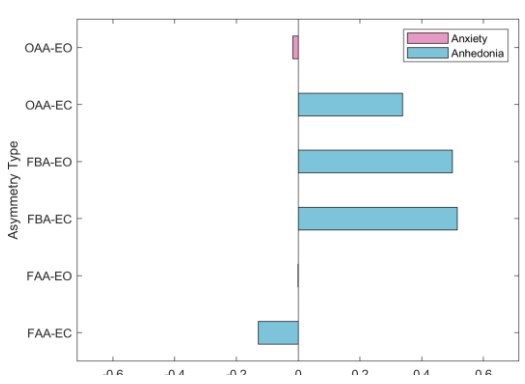

Alpha Blocking

